

INDUCTIVE SENSORS M30 x 1.5



CYLINDRICAL SHORT HOUSING S SERIES
3/4 WIRES D.C.
CONFORMING TO EN 50044
VERSION-C

- STANDARD SWITCHING DISTANCE
- ★ EXTENDED SWITCHING DISTANCE
- ▲ EMBEDDABLE (FLUSH MOUNTING)
- NOT EMBEDDABLE (NON FLUSH MOUNTING)

TECHNICAL CHARACTERISTICS

Dimensions mm

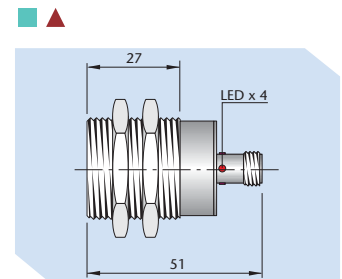
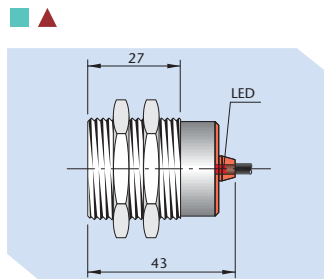

AMPLIFIED 3 WIRES D.C.	NPN	NO	SI30 - C10 NPN NO S	SI30 - C10 NPN NO H S
		NC	SI30 - C10 NPN NC S	SI30 - C10 NPN NC H S
	PNP	NO	SI30 - C10 PNP NO S	SI30 - C10 PNP NO H S
		NC	SI30 - C10 PNP NC S	SI30 - C10 PNP NC H S
AMPLIFIED 4 WIRES D.C. ANTIPHASE	NPN	NO+NC		
	PNP	NO+NC		
Switching distance (Sn)	mm	10		10
Continuous voltage (residual ripple ≤10%)	V		10 ÷ 30	
Hysteresis (%Sn)	mm		< 10%	
Switching frequency	Hz		300	
Repeatability	% of Sn		≤ 3	
Max output current	mA		200	
Absorption at 24Vdc	mA		< 15	
Voltage drop (sensor ON)	V		< 1.8	
Short circuit protection			Incorporated	
Led			Incorporated	
Temperature limits	°C		- 25 ÷ + 70	
Degree of protection	IP	67		Depending on connector
Housing			Nickelled brass	
Cable PVC	2m		3 x 0.35 mm ²	
Connector plug				H

WIRING DIAGRAMS

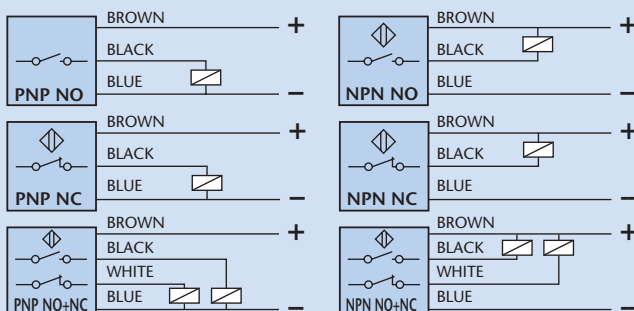

N.B.: On request is available cable for sensors with different length
3.5 - 7.5 - 5 - 10 metres.

CONNECTION WITH H PLUG FOR THE CONNECTORS SEE PAGE 85

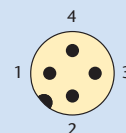

VIEW OF MALE CONNECTOR H

3 WIRES

- 1 = Brown / +
- 3 = Blue / -
- 4 = Black / output NPN-PNP / NO
- 2 = Black / output NPN-PNP / NC

4 WIRES

- 1 = Brown / +
- 3 = Blue / -
- 4 = Black / output NPN-PNP / NO
- 2 = White / output NPN-PNP / NC

On the 4 wires version with plug H the connector types 14 - 15 must be ordered with 4 wires.

Meyer Industrie-Electronic GmbH - MEYLE

Carl-Bosch-Straße 8
49525 Lengerich/Germany
Internet: www.meyle.de

Tel.: (+49) 05481/9385-0
Fax: (+49) 05481/9385-12
E-Mail: sales@meyle.de

INDUCTIVE SENSORS M30 x 1.5

CYLINDRICAL SHORT HOUSING S SERIES
 3/4 WIRES D.C.
 CONFORMING TO EN 50044
 VERSION-C

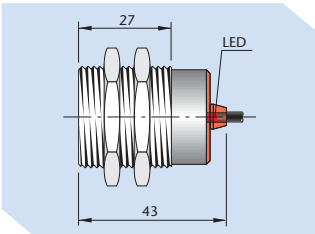
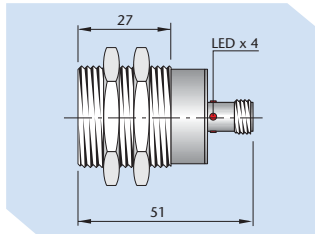
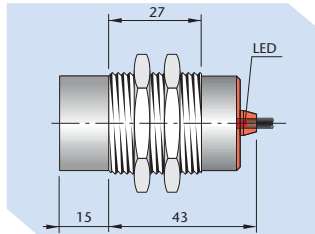
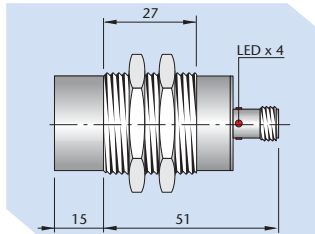

INDUCTIVE

			
SI30 - DC15 NPN NO S	SI30 - DC15 NPN NO H S		
SI30 - DC15 NPN NC S	SI30 - DC15 NPN NC H S		
SI30 - DC15 PNP NO S	SI30 - DC15 PNP NO H S		
SI30 - DC15 PNP NC S	SI30 - DC15 PNP NC H S		
SI30 - DC15 NPN NO + NC S	SI30 - DC15 NPN NO + NC H S	SI30 - DCE20 NPN NO + NC S	SI30 - DCE20 NPN NO + NC H S
SI30 - DC15 PNP NO + NC S	SI30 - DC15 PNP NO + NC H S	SI30 - DCE20 PNP NO + NC S	SI30 - DCE20 PNP NO + NC H S
15	15	20	20
10 ÷ 30			
< 10%			
300		200	
≤ 3			
200			
< 15			
< 1.8			
Incorporated			
Incorporated			
- 25 ÷ + 70			
67	Depending on connector	67	Depending on connector
Nickelled brass			
3 x 0.35 mm ² - 4 x 0.25 mm ²		4 X 0.25 mm ²	
	H		H

INSTRUCTIONS FOR CORRECT INSTALLATION

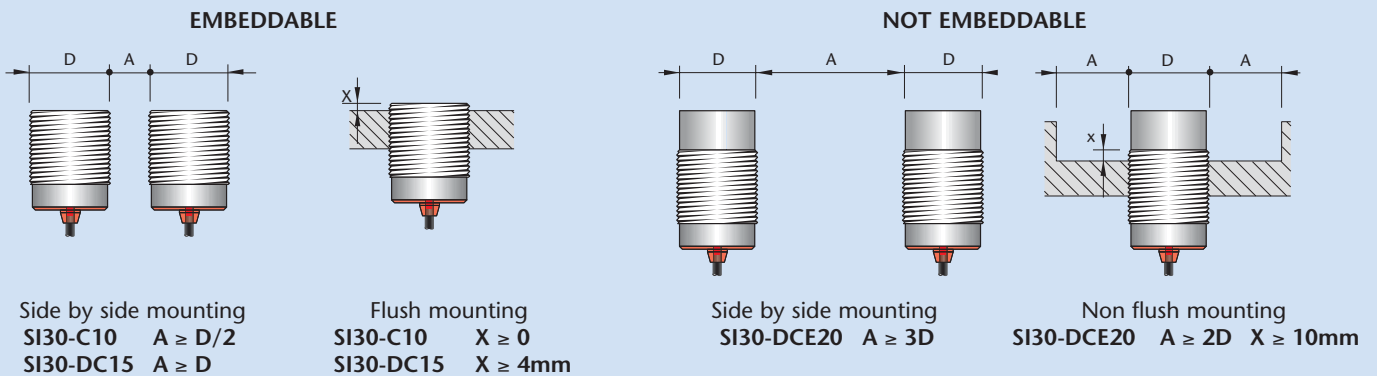

Meyer Industrie-Electronic GmbH - MEYLE

Carl-Bosch-Straße 8
 49525 Lengerich/Germany
 Internet: www.meyle.de

Tel.: (+49) 05481/9385-0
 Fax: (+49) 05481/9385-12
 E-Mail: sales@meyle.de

INDUCTIVE SENSORS M30 x 1.5



CYLINDRICAL LONG HOUSING
3/4 WIRES D.C.
CONFORMING TO EN 50008 - EN 50044
VERSION-C

- STANDARD SWITCHING DISTANCE
- ▲ EMBEDDABLE (FLUSH MOUNTING)
- NOT EMBEDDABLE (NON FLUSH MOUNTING)

TECHNICAL CHARACTERISTICS

Dimensions mm

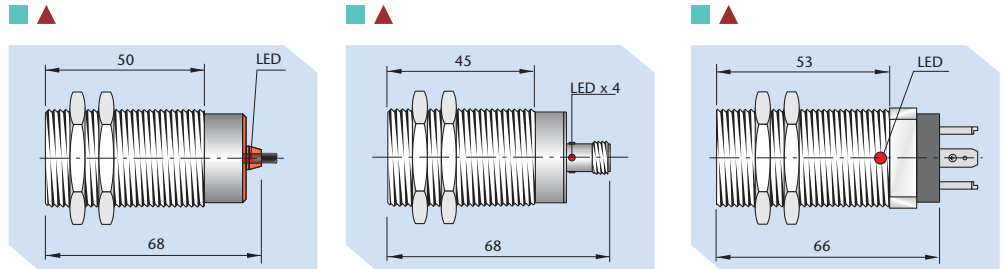

AMPLIFIED 3 WIRES D.C.	NPN	NO	SI30 - C10 NPN NO	SI30 - C10 NPN NO H	SI30 - C10 NPN NO K
		NC	SI30 - C10 NPN NC	SI30 - C10 NPN NC H	SI30 - C10 NPN NC K
	PNP	NO	SI30 - C10 PNP NO	SI30 - C10 PNP NO H	SI30 - C10 PNP NO K
		NC	SI30 - C10 PNP NC	SI30 - C10 PNP NC H	SI30 - C10 PNP NC K
AMPLIFIED 4 WIRES D.C. ANTI-PHASE	NPN	NO+NC	SI30 - C10 NPN NO + NC	SI30 - C10 NPN NO + NC H	SI30 - C10 NPN NO + NC K
	PNP	NO+NC	SI30 - C10 PNP NO + NC	SI30 - C10 PNP NO + NC H	SI30 - C10 PNP NO + NC K
Switching distance (Sn)	mm		10	10	10
Continuous voltage (residual ripple ≤10%)	V			10 ÷ 30	
Hysteresis (%Sn)	mm			< 10%	
Switching frequency	Hz			300	
Repeatability	% of Sn			≤ 3	
Max output current	mA			200	
Absorption at 24Vdc	mA			< 15	
Voltage drop (sensor ON)	V			< 1.8	
Short circuit protection				Incorporated	
Led				Incorporated	
Temperature limits	°C			- 25 ÷ + 70	
Degree of protection	IP		67	Depending on connector	65
Housing			Nickelled brass		
Cable PVC	2m		3 x 0.35 mm ² - 4 x 0.25 mm ²		
Connector plug				H	K (type 12)

WIRING DIAGRAMS

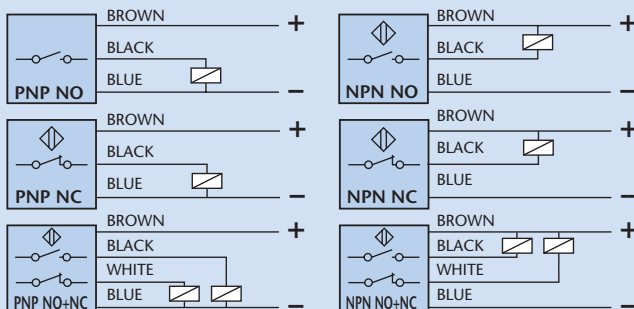

N.B.: On request is available cable for sensors with different length
3.5 - 7.5 - 5 - 10 metres.

CONNECTION WITH H - K PLUGS FOR THE CONNECTORS SEE PAGE 85

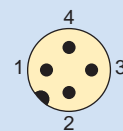

VIEW OF MALE CONNECTOR H

3 WIRES

- 1 = Brown / +
- 3 = Blue / -
- 4 = Black / output NPN-PNP / NO
- 2 = Black / output NPN-PNP / NC

4 WIRES

- 1 = Brown / +
- 3 = Blue / -
- 4 = Black / output NPN-PNP / NO
- 2 = White / output NPN-PNP / NC

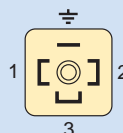

VIEW OF MALE CONNECTOR K

3 WIRES

- 1 = Blue / -
- 2 = Brown / +
- 4/≡ = Black / output NPN-PNP / NO-NC

4 WIRES

- 1 = Blue / -
- 2 = Brown / +
- 4/≡ = Black / output NPN-PNP / NO
- 3 = White / output NPN-PNP / NC

On the 3 wires version with plug K the connector K is supplied with 3 poles.
On the 4 wires version with plug H the connector types 14 - 15 must be ordered with 4 wires.

Meyer Industrie-Electronic GmbH - MEYLE

Carl-Bosch-Straße 8
49525 Lengerich/Germany
Internet: www.meyle.de

Tel.: (+49) 05481/9385-0
Fax: (+49) 05481/9385-12
E-Mail: sales@meyle.de

INDUCTIVE SENSORS M30 x 1.5

CYLINDRICAL LONG HOUSING

3/4 WIRES D.C.

CONFORMING TO EN 50008 - EN 50044

VERSION-C



INDUCTIVE

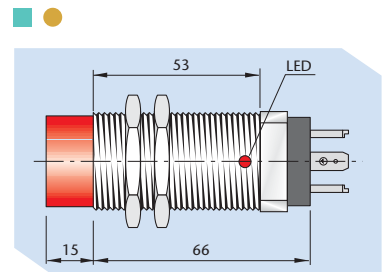
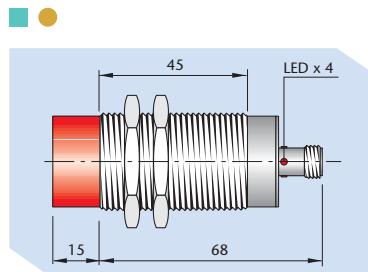
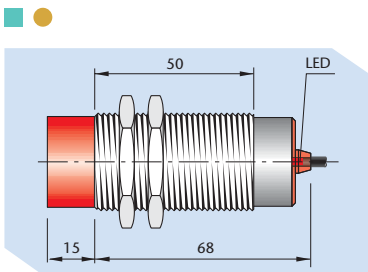

SI30 - CE15 NPN NO	SI30 - CE15 NPN NO H	SI30 - CE15 NPN NO K
SI30 - CE15 NPN NC	SI30 - CE15 NPN NC H	SI30 - CE15 NPN NC K
SI30 - CE15 PNP NO	SI30 - CE15 PNP NO H	SI30 - CE15 PNP NO K
SI30 - CE15 PNP NC	SI30 - CE15 PNP NC H	SI30 - CE15 PNP NC K
SI30 - CE15 NPN NO + NC	SI30 - CE15 NPN NO + NC H	SI30 - CE15 NPN NO + NC K
SI30 - CE15 PNP NO + NC	SI30 - CE15 PNP NO + NC H	SI30 - CE15 PNP NO + NC K
15	15	15
	10 ÷ 30	
	< 10%	
	300	
	≤ 3	
	200	
	< 15	
	< 1.8	
	Incorporated	
	Incorporated	
	- 25 ÷ + 70	
67	Depending on connector	65
	Nickelled brass	
3 x 0.35 mm ² - 4 x 0.25 mm ²		
	H	K (type 12)

INSTRUCTIONS FOR CORRECT INSTALLATION

EMBEDDABLE

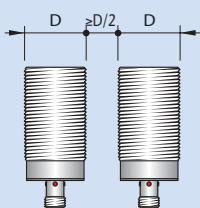

Side by side mounting

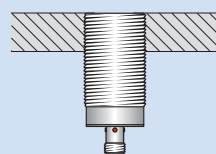

Flush mounting

NOT EMBEDDABLE

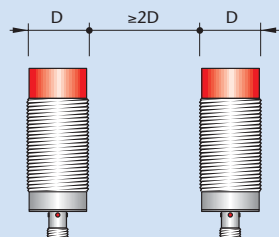

Side by side mounting

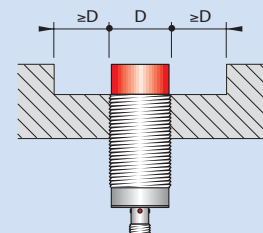

Non flush mounting

Meyer Industrie-Electronic GmbH - MEYLE

Carl-Bosch-Straße 8
49525 Lengerich/Germany
Internet: www.meyle.de

Tel.: (+49) 05481/9385-0
Fax: (+49) 05481/9385-12
E-Mail: sales@meyle.de

INDUCTIVE SENSORS M30 x 1.5



CYLINDRICAL LONG HOUSING
2 WIRES D.C.
CONFORMING TO EN 50040 - EN 50044
VERSION -B

- STANDARD SWITCHING DISTANCE
- ▲ EMBEDDABLE (FLUSH MOUNTING)
- NOT EMBEDDABLE (NON FLUSH MOUNTING)

TECHNICAL CHARACTERISTICS

Dimensions mm

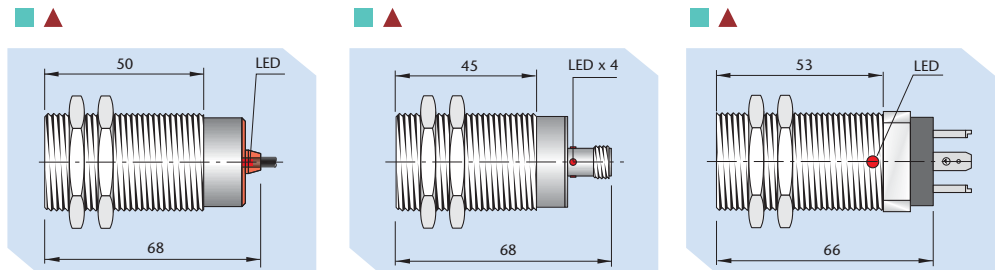

		Standard Switching Distance		
		SI30 - B10 NO	SI30 - B10 NO H	SI30 - B10 NO K
AMPLIFIED	NO	SI30 - B10 NO	SI30 - B10 NO H	SI30 - B10 NO K
2 WIRES D.C.	NC	SI30 - B10 NC	SI30 - B10 NC H	SI30 - B10 NC K
Switching distance (Sn)	mm	10	10	10
Continuous voltage (residual ripple ≤10%)	V	10 ÷ 55		
Hysteresis (%Sn)	mm	< 10%		
Switching frequency	Hz	300		
Repeatability	% of Sn	≤ 3		
Max output current	mA	100		
Min. output current	mA	1.5		
Residual current	mA	< 0.6		
Voltage drop (sensor ON)	V	< 6.5		
Short circuit protection		Incorporated		
Led		Incorporated		
Temperature limits	°C	- 25 ÷ + 70		
Degree of protection	IP	67	Depending on connector	65
Housing		Nickelled brass		
Cable PVC	2m	2 x 0.50 mm ²		
Connector plug			H	K (type 12)

WIRING DIAGRAMS (2 WIRES NON POLARIZED)

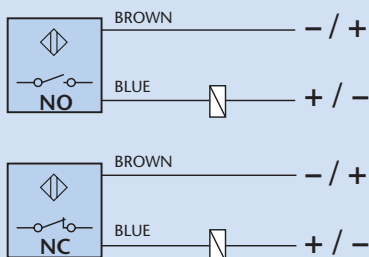

N.B.: On request is available cable for sensors with different length
3.5 - 7.5 - 5 - 10 metres.

CONNECTION WITH H - K PLUGS

FOR THE CONNECTORS SEE PAGE 85

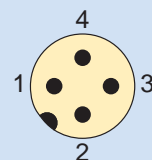

VIEW OF MALE CONNECTOR H
3 / 4 = Function NO (Black-blue)*
1 / 2 = Function NC (White-brown)*
(Non polarized)
* The wire colour are referred to the connector with cable only.

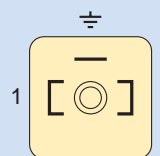

VIEW OF MALE CONNECTOR K
1 / 2 = Function NO
1 / 2 = Function NC
(Non polarized)

INDUCTIVE SENSORS M30 x 1.5



CYLINDRICAL LONG HOUSING
 2 WIRES D.C.
 CONFORMING TO EN 50040 - EN 50044
 VERSION -B

INDUCTIVE

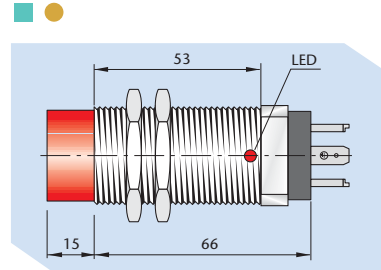
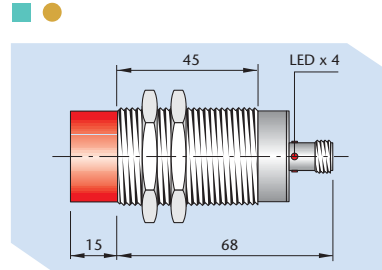
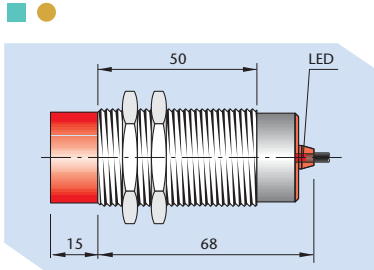

SI30 - BE15 NO	SI30 - BE15 NO H	SI30 - BE15 NO K
SI30 - BE15 NC	SI30 - BE15 NC H	SI30 - BE15 NC K
15	15	15
10 ÷ 55		
< 10%		
300		
≤ 3		
100		
1.5		
< 0.6		
< 6.5		
Incorporated		
Incorporated		
- 25 ÷ + 70		
67	Depending on connector	65
Nickelled brass		
2 x 0.50 mm ²		
	H	K (type 12)

INSTRUCTIONS FOR CORRECT INSTALLATION

EMBEDDABLE

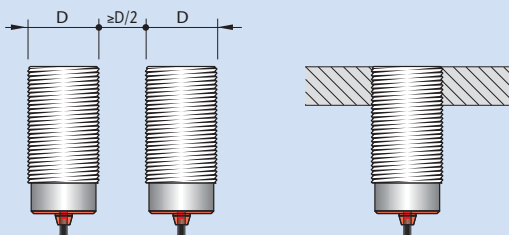

Side by side mounting

Flush mounting

NOT EMBEDDABLE

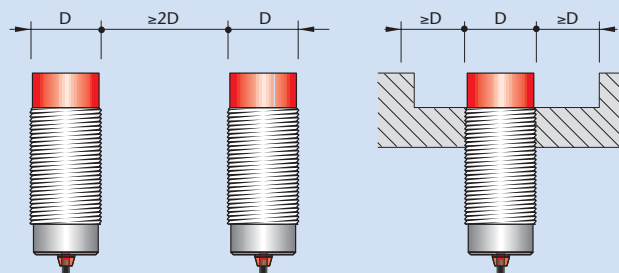

Side by side mounting

Non flush mounting

Meyer Industrie-Electronic GmbH - MEYLE

Carl-Bosch-Straße 8
 49525 Lengerich/Germany
 Internet: www.meyle.de

Tel.: (+49) 05481/9385-0
 Fax: (+49) 05481/9385-12
 E-Mail: sales@meyle.de

INDUCTIVE SENSORS M30 x 1.5



CYLINDRICAL LONG HOUSING
2 WIRES A.C.
CONFORMING TO EN 50036 - EN 50044
VERSION-A

- STANDARD SWITCHING DISTANCE
- ▲ EMBEDDABLE (FLUSH MOUNTING)
- NOT EMBEDDABLE (NON FLUSH MOUNTING)

TECHNICAL CHARACTERISTICS

Dimensions mm

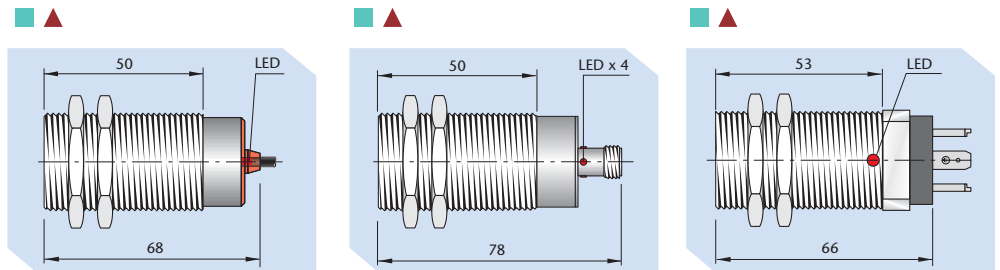

AMPLIFIED 2 WIRES A.C.	NO	SI30 - A10 NO	SI30 - A10 NO H	SI30 - A10 NO K
	NC	SI30 - A10 NC	SI30 - A10 NC H	SI30 - A10 NC K
Switching distance (Sn)	mm	10	10	10
Alternating voltage 50÷ 60 Hz	V	20 ÷ 250		
Hysteresis (%Sn)	mm	< 10%		
Switching frequency	Hz	12		
Repeatability	% of Sn	≤ 3		
Max output current	mA	300		
Min. output current	mA	5		
Max. peak current for 20ms	A	1.5		
Residual current	mA	< 1		
Voltage drop (sensor on)	V	< 6		
Led		Incorporated		
Temperature limits	°C	- 25 ÷ + 70		
Degree of protection	IP	67	Depending on connector	65
Housing		Nickelled brass		
Cable PVC	2m	2 x 0.50 mm ²		
Connector plug			H	K (type 12)

WIRING DIAGRAMS

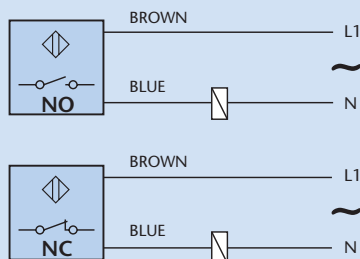

N.B.: On request is available cable for sensors with different length
3.5 - 7.5 - 5 - 10 metres.

CONNECTION WITH H - K PLUGS FOR THE CONNECTORS SEE PAGE 85

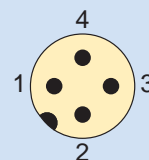

VIEW OF MALE CONNECTOR H
3 / 4 = Function NO (Black-blue)*
1 / 2 = Function NC (White-brown)*
* The wire colour are referred to the connector with cable only.

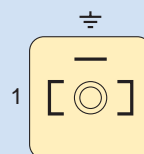

VIEW OF MALE CONNECTOR K
1 / 2 = Function NO
1 / 2 = Function NC

INDUCTIVE SENSORS M30 x 1.5

CYLINDRICAL LONG HOUSING

2 WIRES A.C.

CONFORMING TO EN 50036 - EN 50044

VERSION-A



INDUCTIVE

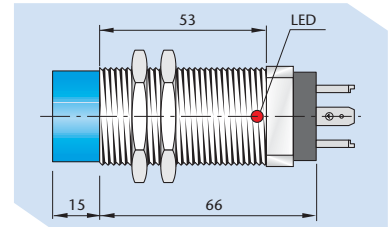
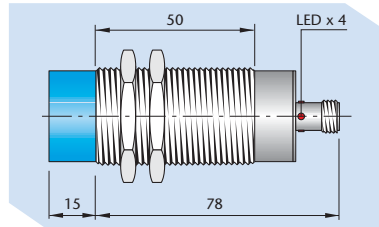
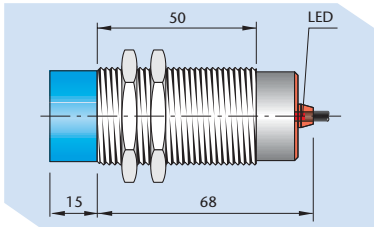

SI30 - AE15 NO	SI30 - AE15 NO H	SI30 - AE15 NO K
SI30 - AE15 NC	SI30 - AE15 NC H	SI30 - AE15 NC K
15	15	15
20 ÷ 250		
< 10%		
12		
≤ 3		
300		
5		
1.5		
< 1		
< 6		
Incorporated		
- 25 ÷ + 70		
67	Depending on connector	65
Nickelled brass		
2 x 0.50 mm ²		
	H	K (type 12)

INSTRUCTIONS FOR CORRECT INSTALLATION

EMBEDDABLE

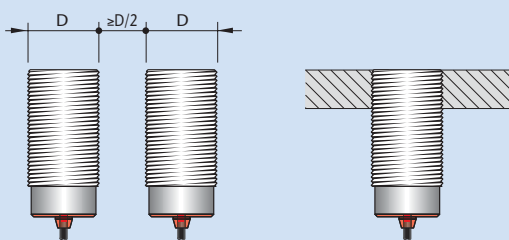

Side by side mounting

Flush mounting

NOT EMBEDDABLE

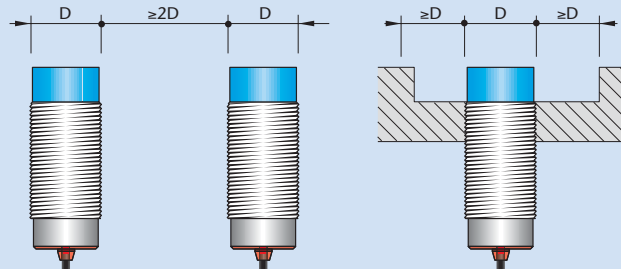

Side by side mounting

Non flush mounting

Meyer Industrie-Electronic GmbH - MEYLE

Carl-Bosch-Straße 8
49525 Lengerich/Germany
Internet: www.meyle.de

Tel.: (+49) 05481/9385-0
Fax: (+49) 05481/9385-12
E-Mail: sales@meyle.de